



opentec

Series 5 RPT 8 User Guide (April 2008)

Covers the following Rugged Portable Tablet models:

RPT 8X-I (industrial/commercial model)

Openfire RPT 8X-M (Mil-spec model)



For when the going gets beyond tough

Copyright Notices

Revision Date: April 8, 2008

The following are registered trademarks of Opentec Solutions Pty Ltd:

- *'RPC' Rugged Portable Computer*
- *'Openfire RPC' Mil-Spec Rugged Portable Computer*
- *'RPT' Rugged Portable Tablet*
- *'Openfire RPT' Mil-Spec Rugged Portable Tablet*
- *'Jackaroo RPT' Rugged Portable Tablet*
- *'RPDA' Rugged Personal Data Assistant*
- *'Openfire RPDA' Mil-Spec Rugged Personal Data Assistant*
- *'Jillaroo' Rugged Personal Data Assistant*
- *'Perente' Portable Tablet*

No part of this publication may be processed; such as reproduced, transmitted, transcribed, stored in a retrieval system, translated into any computer language in any form, or by any means of electronic, mechanical, magnetic, optical, chemical, or others without the prior written permission of the manufacturer.

Trademark Acknowledgments

Windows is registered trademarks of Microsoft Corp.

Intel® Core™2 Duo processor is the registered trademark of Intel Corp.

All product and company names, trade names or trademarks are the property of their respective owners.

Disclaimer

Due to on-going product development, product specifications, features, performance, specifications, etc, might vary from those published here. Always check with Opentec or your authorised Opentec Agent to establish product specifications when evaluating our products, and before ordering.

The manufacturer reserves the right to revise this publication and to make changes to the contents here of without obligation to notify any person of such revision or changes.

The manufacturer makes no representations or warranties, either expressed or implied, about the contents and specifically disclaims any warranties as to merchantability or fitness for any particular purpose. Any of the software described in this manual is sold or licensed "as is". Should the programs prove defective following purchase, the buyer (and not the manufacturer, its distributor, or its dealer) assumes the entire cost of all necessary servicing, repair and any incidental or consequential damages resulting from any software defects.

Copyright © 2008 Opentec Solutions Pty Limited. All rights reserved.

EMC and Safety Notices

CE

Products with the CE Marking comply with both the EMC Directive (89/336/EEC) and the Low Voltage Directive (73/23/EEC) issued by the Commission of the European Community. Compliance with these directives implies conformity to the following European Norms:

EN55022 (CISPR 22) Radio Frequency Interference

EN55024 (EN61000-4-2, EN61000-4-3, EN61000-4-4, EN61000-4-5, EN61000-4-6, EN61000-4-8, EN61000-4-11, EN61000-3-2, EN61000-3-3) Generic Immunity Standard

EN60950 (IEC950) Product Safety

R&TTE (CE) Manual Regulatory Requirement (WLAN - IEEE 802.11b/g)

802.11b/g Restrictions:

European standards dictate maximum radiated transmit power of 100mW EIRP and frequency range 2.400-2.4835 GHz. In France, the equipment must be restricted to the 2.4465-2.4835 GHz frequency range and must be restricted to indoor use.

CE Declaration of Conformity



Is herewith confirmed to comply with the requirements set out in the Council Directive on the approximation of the laws of the member states relating to Electromagnetic Compatibility (89/336/EEC), Low-voltage Directive (73/23/EEC) and the Amendment Directive (93/68/EEC), the procedures given in European Council Directive 99/5/EC and 89/3360EEC.

The equipment was passed. The test was performed according to the following European standards.

EN 300 328 V.1.4.1 (2003-04)

EN 301 489-1 V.1.4.1 (2002-04)/EN 301 489-17 V.1.2.1 (2002-04)

EN 50371:2002

EN 60950:2000

FCC Regulations:

This device has been tested and found to comply with the limits for a Class B digital device, pursuant to Part 15 of the FCC Rules. These limits are designed to provide reasonable protection against harmful interference in a residential installation. Operation is subject to the following two conditions:

- (1) This device may not cause harmful interference.
- (2) This device must accept any interference received, including interference that may cause undesired operation.

This equipment generates, uses and can radiate radio frequency energy and, if not installed and used in accordance with the instructions, may cause harmful interference to radio communications. However, there is no guarantee that interference will not occur in a particular installation. If this equipment does cause harmful interference to radio or television reception, which can be determined by turning the equipment off and on, the user is encouraged to try to correct the interference by one or more of the following measures:

- Re-orient or relocate the receiving antenna.
- Increase the separation between the equipment and receiver.
- Connect the equipment into an outlet on a circuit different from that to which the receiver is connected.
- Consult the dealer or an experienced radio/TV technician for help.

Changes or modifications not expressly approved by the party responsible for compliance could void the user's authority to operate the equipment.

This device complies with FCC radiation exposure limits set forth for an uncontrolled environment. In order to avoid the possibility of exceeding the FCC radio frequency exposure limits, human proximity to the antenna shall not be less than 20cm (8 inches) during normal operation.

RF Exposure Information (SAR)

This device meets the government's requirements for exposure to radio waves. This device is designed and manufactured not to exceed the emission limits for exposure to radio frequency (RF) energy set by the Federal Communications Commission of the U.S. Government.

The exposure standard employs a unit of measurement known as the Specific Absorption Rate, or SAR. The SAR limit set by the FCC is 1.6W/kg. Tests for SAR are conducted using standard operating positions accepted by the FCC with the EUT transmitting at the specified power level in different channels.

The highest SAR value for the device as reported to the FCC is **0.789** W/kg when placed next to the body.

The FCC has granted an Equipment Authorisation for this device with all reported SAR levels evaluated as in compliance with the FCC RF exposure guidelines. SAR information on this device is on file with the FCC and can be found under the Display Grant section of <http://www.fcc.gov/oet/fccid> after searching on FCC ID: **IR5DR886EX**.

Regulatory Information/Disclaimers

Installation and use of this computer must be in strict accordance with the instructions included in the user documentation provided with the product. Any changes or modifications (including the antennas) made to this device that are not expressly approved by the manufacturer may void the user's authority to operate the equipment.

The manufacturer is not responsible for any radio or television interference caused by unauthorised modification of this device, or the substitution of the connecting cables and equipment other than manufacturer specified. It is the responsibility of the user to correct any interference caused by such unauthorised modification, substitution or attachment. Manufacturer and its authorised resellers or distributors will assume no liability for any damage or violation of government regulations arising from failing to comply with these guidelines.

Important Note

FCC RF Radiation Exposure Statement:

This equipment complies with FCC RF radiation exposure limits set forth for an uncontrolled environment. This device and its antenna must not be co-located or operated with any other antenna or transmitter.

UL, TÜV

AC Adapter (TÜV includes EN60950 LVD)

Power Conservation

This computer consumes much less power than conventional computers. However, power consumption may be reduced by properly configuring the Power Management Setup. It is recommended the power saving functions be enabled even when not running on battery power. Please read the power saving features and the setting procedures described in this manual for setting your computer.

Environmental Information, Material Safety and Recycling

Caution: *Risk of explosion if battery is replaced by an incorrect type.
Dispose of used batteries according to the instructions.*

All materials used in the construction of this equipment are recyclable or environmentally friendly.

Please recycle the packing materials, and at the end of the product's life, all other materials by local regulations.

Please refer "Material and Recycling" for the contents of the materials.

- The equipment may still contain tiny amount of hazardous substances for health and environment, though those are below control level.
- To avoid spreading such substances into the eco system, and to minimise the pressure on the natural, you are encouraged to use the appropriate take-back. Those will reuse or recycle most of the materials in a sound way after end life.
- The crossed bin symbol indicates proper disposal is required.
- For more information on collection, reuse and recycling, please consult local or regional waste administration.
- You can also contact the dealer for more information on the environmental details of the equipment.

CONTENTS

GETTING STARTED	2
UNPACKING	2
QUICK CHECK	3
CONTROLS AND INDICATORS	4
COMPONENTS AND OPERATIONS	8
LOCATION	8
RUGGEDNESS	8
OPERATING SYSTEMS	8
AC ADAPTER	8
BATTERY	9
BOOT UP AND POST	10
TIMEOUT/STANDBY/WAKE UP	10
SHUTDOWN	11
RTC	11
SAFE GUARD THE COMPUTER	11
REPLACING MODULES	12
HARD DISK DRIVE	12
TOUCH SCREEN	13
PCMCIA CARD	13
EXPRESS CARD	13
EXTERNAL BACKLIGHT KEYBOARD (OPTION)	13
DOCKLIGHT (OPTION)	14
STAND UNIT (OPTION)	15
HEATER	15
RF DEVICE	15
OPTIONAL DEVICES	16
MEMORY CARD	16
2 ND BATTERY	16
WIRELESS LAN CARD	16
MDC MODEM CARD	16
VEHICLE ADAPTER	16
DUAL BATTERY CHARGER	16
DOCKLIGHT	16
STAND UNIT	16
RF DEVICE	16
SPECIFICATIONS	17
CPU	17
MEMORY	17
DISPLAY	17
LCD	17
HARD DISK DRIVE	17
TOUCH SCREEN	17
I/O PORTS	18
DIMENSIONS AND WEIGHT	18
AC ADAPTER	18
BATTERY	18
KEYPAD/KEYBOARD	18
VEHICLE ADAPTER (OPTION)	18
DOCKLIGHT DL-8I/DL-8M (OPTION)	19
STAND UNIT (OPTION)	19
MATERIALS AND RECYCLING	20
ENVIRONMENTAL	20
BIOS SETUP	20
MAIN MENU	20
IDE CHANNEL 0 MASTER SUB-MENU	22
IDE CHANNEL 0 SLAVE SUB-MENU	23

IDE CHANNEL 1 MASTER SUB-MENU	24
IDE CHANNEL 1 SLAVE SUB-MENU	25
ADVANCED MENU.....	26
SIO SMC227 CONFIGURATION SUB-MENU	28
SECURITY MENU	30
RF SECURITY CONTROL SUB-MENU.....	32
TPM STATE MENU.....	33
BOOT MENU	34
EXIT MENU	35
UTILITIES AND DRIVERS	35
CHIPSET	35
VGA UTILITY	36
AUDIO DRIVER.....	36
USB 2.0	36
TOUCH SCREEN DRIVER.....	37
PCMCIA DRIVER.....	37
MINI PCI 1G AX92200 LAN.....	37
MINI PCI INT8100 LAN.....	37
MINI PCI-E 1G RTL8111B LAN.....	37
MINI PCI-E INTEL 3945ABG WLAN	37
FAX/MODEM CARD DRIVER	37
WIRELESS MANAGER.....	37
INPUT MANAGEMENT SERVICES	38
MAINTENANCE/SERVICE	44
CLEANING.....	44
TROUBLESHOOTING	44
RMA SERVICE	44

GETTING STARTED

Unpacking

The following components come with your computer. If anything is missing or damaged, please notify the dealer immediately.

- Computer unit
- AC Adapter
- AC Power Cord
- Utility CD
- User's Guide

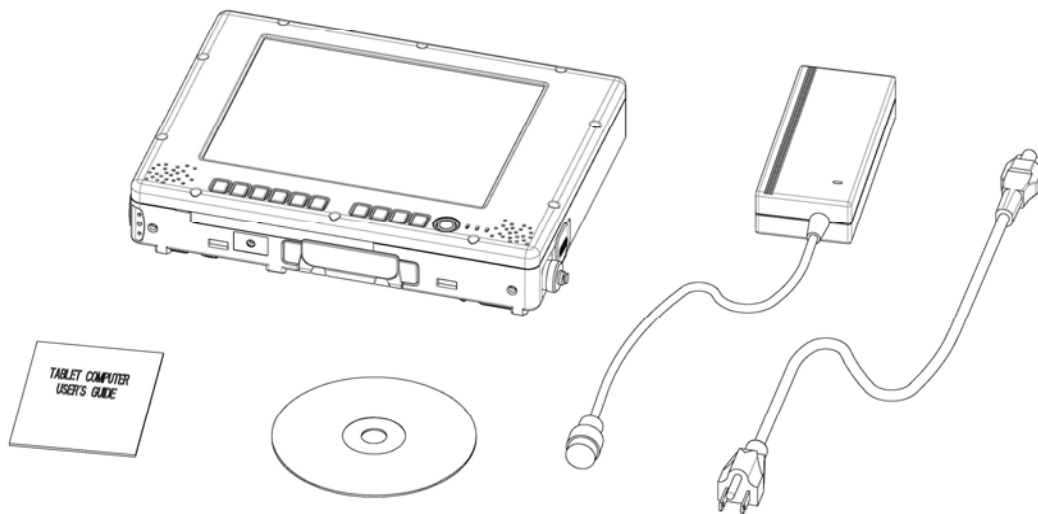

Quick Check

- Insert the battery into compartment; fix the screw till battery is in position.
- Attach the AC adapter and charge battery for at least 10 minutes.

Turn ON the computer by pressing the power button momentarily.

Notice:

- When ambient temperature is under 0°C, the system may not boot up immediately. System will beep with charge light flashing while heater working. After 13~15 minutes, the system will boot up automatically
-
- Under emergency situation, to skip heating and boot up system immediately by pressing power button for >10 seconds. (But can not guarantee all devices on the computer work properly)
-
- Turn OFF the computer using either one of the following procedures:
 1. Press power button momentarily to “Standby”* or “Hibernate”* dependent on operating system (OS) and power scheme settings.
 2. Press power button for 4 seconds to have a “Hard” power off. System shuts down without saving any data or parameters.

**: Some operating systems may not support these functions.*

3. Click **Start** → **Shut Down** in Windows to **Turn OFF**.

Driver or application software installation may be necessary for further operation.

Controls and Indicators

Note: Some of the functions are optional.

Top

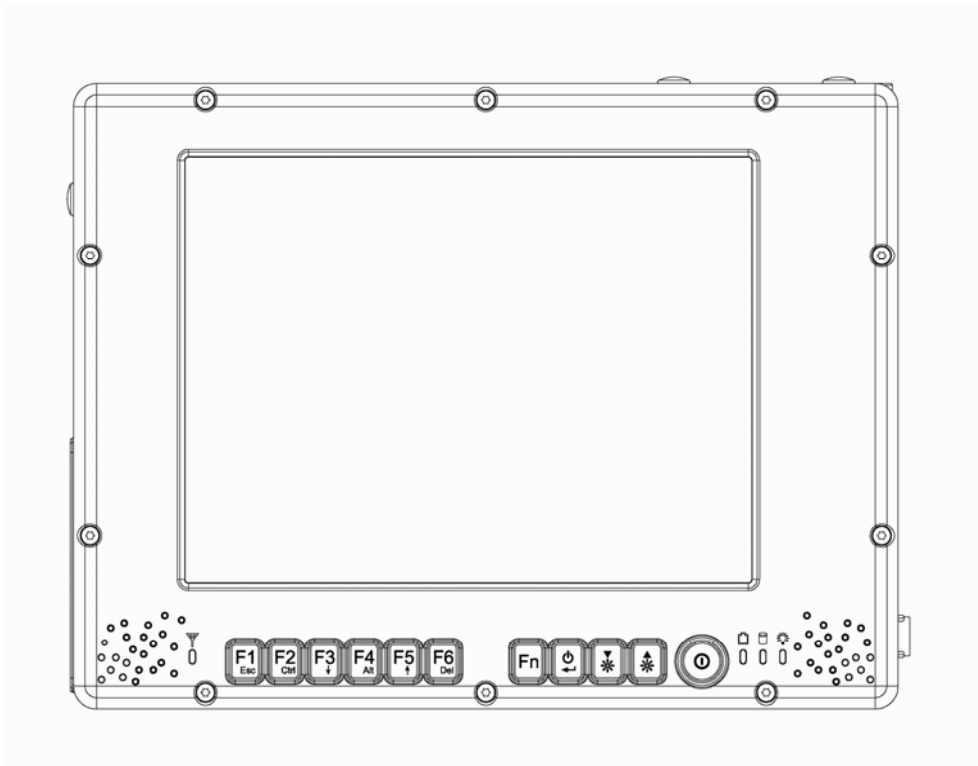

RF device indicator

F1~F6: Function keys, blue font are alternative functions enabled by pressing Fn and the key simultaneously

Fn: To enable alternative function keys



Sleep button (Refer "Timeout/Standby/Wake up")



Display brightness decrease



Display brightness increase



Power button (Refer "Timeout/Standby/Wake up")



Battery charge/heater activity indicator

ON: Charging

OFF: Battery full (Also applies when battery is removed)

Flash: Heater active (Heater is an optional device)



HDD (Hard Disk Drive) activity indicator



Power indicator

Rear

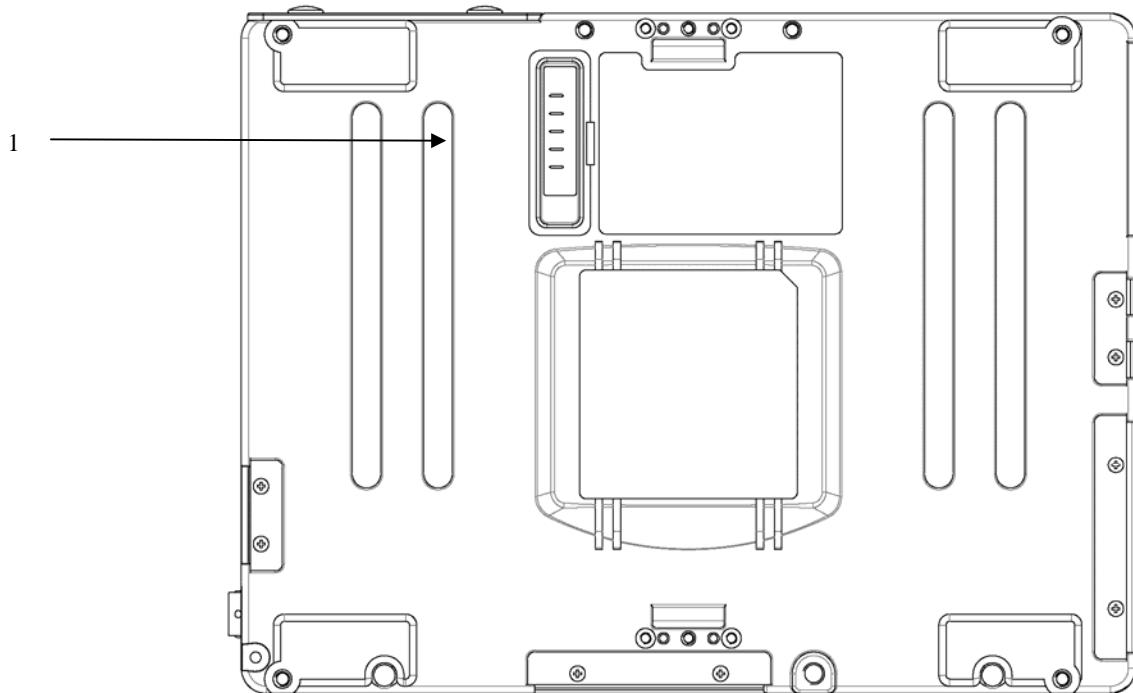

1. Secondary battery connector

Left

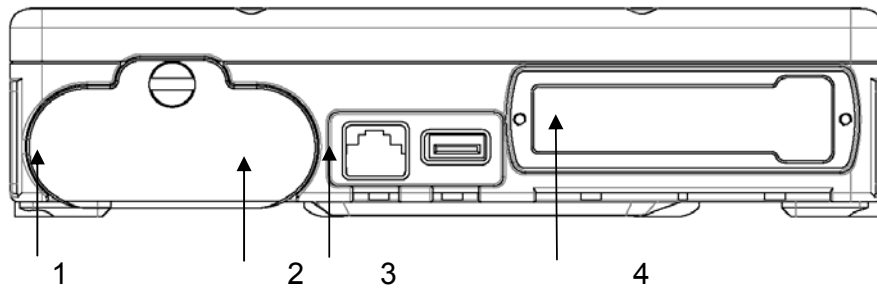

1. Battery
2. LAN
3. USB (Universal Serial Bus)
4. PCMCIA slots or Express Card

Right

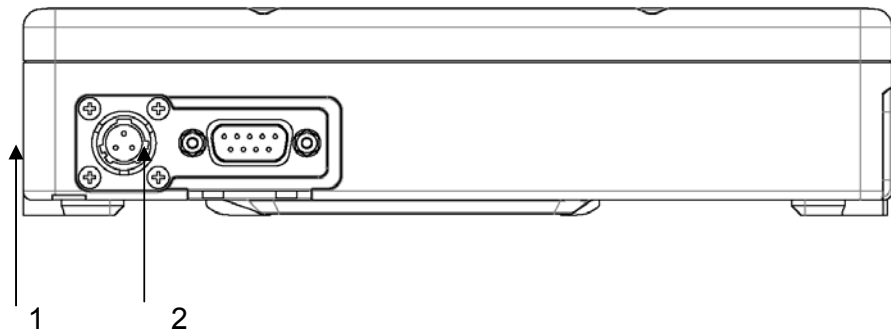

1. DC jack (2 pin for RPT 8-I, 3 pin for RPT 8-M)
2. Serial port (COM1)

Top

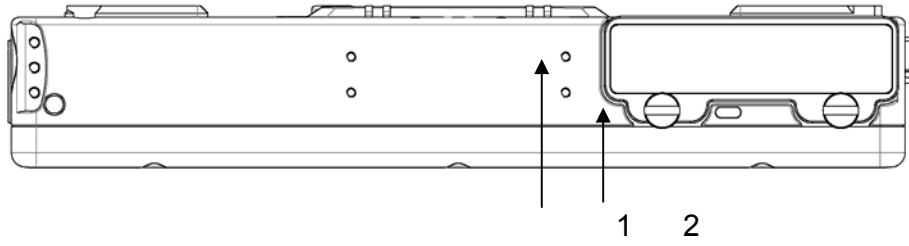

- 1. HDD
- 2. Kensington lock slot

Bottom

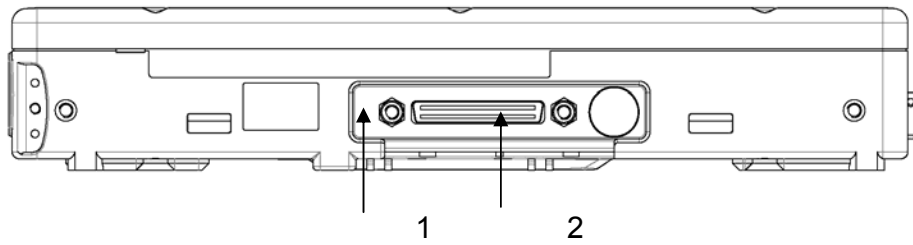

- 1. Docking connector
- 2. External antenna jack (Option)

COMPONENTS AND OPERATIONS

Location

A clean and moisture-free environment is preferred. Make room for air circulation. Avoid areas with:

- Sudden or extreme changes in temperature.
- Extreme heat.
- Strong electromagnetic fields (near television set, motor rotation area, etc.).
- Dust or high humidity.

If it is necessary to work in a hostile environment, please regularly maintain your computer by cleaning dust, water, etc. and keep it in optimal condition.

Ruggedness

The computer is designed with rugged features such as vibration, shock, dust, and rain/water protection. However, it is still necessary to provide appropriate protection while operating in harsh environments.

NEVER immerse the computer in water. Doing so may cause permanent damages. Drop may cause parts break or permanent damages.

The D-sub connector cap is for dust and shock protection only. The connector itself is sealed internally. Other I/O ports and devices must have caps tightly closed or cable inlets sealed while exposed to water or dust.

All connectors will corrode if exposed to water or moisture. Corrosion is accelerated if the power is ON. Please take proper measures in cable connection to avoid water entering into connectors.

The DC jack and cables are sealed and may be operated with water splashing while attached. All port covers should be in place when no cable is attached.

Operating Systems

The computer is compatible with most operating systems (OS). However, not all functions are 100% compatible. For example, ACPI, APM, Smart Battery, etc. are not available on DOS, Windows NT, and other non-Microsoft OS. Consequently "Standby", "Hibernation", "Battery Gauge" etc. would not work under such operating systems.

ACPI: Advanced Configurations and Power Interface

APM: Advanced Power Management

AC Adapter

The AC adapter performs two functions:

- It powers the computer from an external AC source.
- It charges the computer battery.

The adapter automatically detects the AC line voltage (110V or 220V) and adjusts accordingly.

The following are recommended when using the AC adapter:

- Use a properly grounded AC outlet.
- Use one AC outlet exclusively for the computer. Having other appliances on the same line may cause interference.
- Use a power strip with built-in surge protection.

Connect the AC adapter:

- Plug the AC cord to the adapter.
- Plug the other end of the AC cord into the wall outlet. Make sure the green LED on the adapter turns on.
- Attach the DC plug into the power jack of the computer; turn the lock ring clockwise to secure it.

AC Adapter Indicator

The green LED indicates that AC power is ready.

Battery

The computer will automatically switch to battery when the external power source (AC adapter or optional vehicle adapter) is disconnected.

Battery Power Saving Tips

The computer comes with an intelligent power-saving feature. You may extend the battery life by:

- Setup power saving functions in Operating System Power Management options (e.g. Windows Power Options).
- Setup power saving functions in BIOS “Power Management Setup” (mainly for non-ACPI/APM operating systems).
- Lower the intensity of the display by brightness control.
- Turn the computer into standby (by Sleep or Power button) when it is temporarily not in use.
- Shut down the computer when it will not be in use for longer period of time.

Battery Low

When the battery is nearly exhausted, the computer gives the following “Battery Low” warnings:

- Windows battery low warning.
- The power LED flashes.

Once the “Battery Low” warning occurs, please:

- Save and close the files you are currently working on then shut down the computer.
- Plug in AC or vehicle adapter to recharge the battery.

Battery Gauge

You may check battery status from battery gauge in Windows. Click the power/battery icon to reveal the battery gauge window.

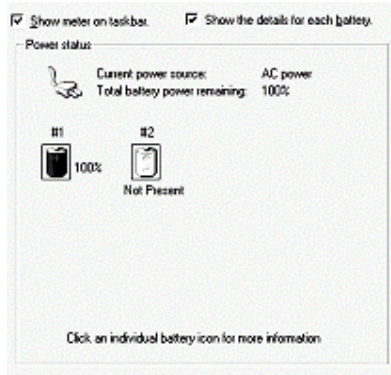

Note: *Battery characteristic varies depending on factors such as ambient temperature, charging method, load current, aging, etc. For example, the chemicals of the battery are more inactive at low temperature, thus decreases the output power.*

The battery gauge should only be used as a reference. Please do not expect it to show the exact amount of the power remaining. There is no memory effect on Lithium Ion battery cells. However, discharge the battery to nearly empty every month will help calibrating the internal gauge

Charging the Battery

Plug in the AC adapter or vehicle adapter to start the battery charging. If the battery is already full, the sense circuitry will stop high current charge within several minutes.

The LED Indicator turns ON when the battery is charging and turns OFF when the battery charge is completed.

To charge the Secondary Battery, simply install it into the computer and attach the AC adapter. The internal charger will charge the Primary and Secondary batteries simultaneously. Optional Dual Battery Charger can charge Primary and Secondary batteries externally.

Boot Up and POST

The computer turns ON and loads the operating system (such as Windows) into the system memory. This start-up procedure is called "boot up".

The ROM BIOS Power On Self-Test (POST)

Each time the computer powers on, it automatically performs a self-test of its memory and hardware devices.

Timeout/Standby/Wake up

In Windows Control Panel Power Options you may set preferred options. If timeouts are set, the sequences of function are as follows:

- **Normal** → **Timeout (Monitor, HDD)** → **Touch screen or any key** → **Wake up (Normal)**
- **Normal** → **Timeout (Standby, Hibernate)** → **Power button** → **Wake up (Normal)**

Directly press sleep button or power button the functions are as follows:

- **Normal** → **Sleep button** → **Standby** (also locks all function keys & touch screen) → **Power button** → **Wake up (Normal)**
- **Normal** → **Power button** → **Standby/Hibernate/Shut down/etc.** (depends on power button setting)
-

Note: *Timeout/Standby works under both AC adapter and battery mode. Some functions may not work under Windows NT or other non-Windows operating systems.*

Shutdown

The following procedure is recommended in shutting down the computer:

1. Save any work you want to keep.
2. Make sure none of the disk drives are active (HDD and CD-ROM drive).
3. Remove any diskettes, CD-ROMs, or other media.
4. Follow the shut down procedure of your Operating System.

Failure to shut down the computer properly may result in loss of data or hardware damages.

Automatic shut down is activated at battery exhaust. Be sure to finish your work and save all your data when the battery low warning appears.

RTC

Battery backed up RTC (Real Time Clock/Calendar) is built in an on-board CMOS (Complementary Metal Oxide Semiconductor) chip. The RTC keeps track of the time and date while the computer is off. The CMOS chip also stores system setup information.

RTC battery is also recharged when AC adapter is attached.

Tips: *When computer is not used for longer period, recharge it at least once per month to ensure RTC operation.*

Safe Guard the Computer



Plug the Kensington lock into the slot near HDD and turn lock it. Both the computer and HDD are secured.

Kensington lock is a widely available 3rd party product.

Replacing Modules

Caution! Turn OFF the power before replacing any module.

To remove the modules:

1. Turn OFF the computer. (“Hibernate” or “suspend to disk” are not recommended as the parameters may change when modules are changed.)
2. Disconnect all cables from the computer.
3. Use a coin to turn loose the screws on the modules.
4. Remove the battery from the compartment.
5. Remove the HDD from the computer.

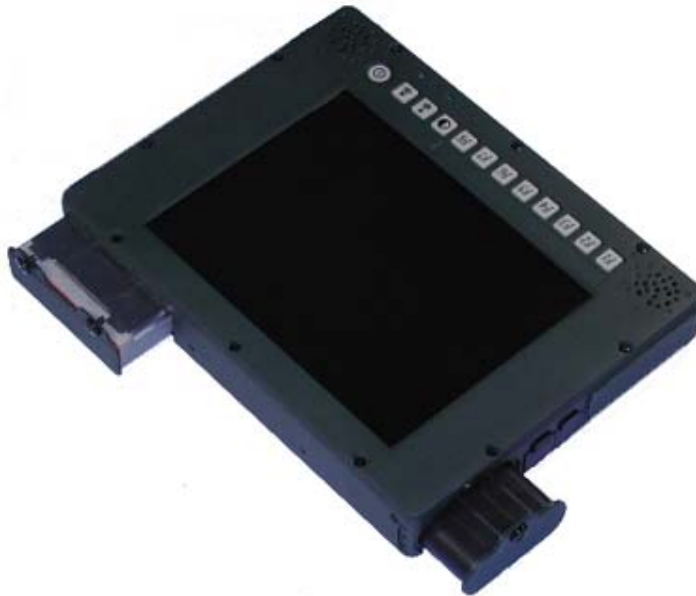

To re-install the modules:

Gently push the module into the slot. Fasten the screw to fix the module. Make sure the o-rings are firmly fixed. No sealant is necessary for the o-rings.

Hard Disk Drive

The Hard Disk Drive (HDD) is a 2.5” type standard serial ATA interface data storage device.

HDD is user removable. This provides convenience and security. It can **ONLY** be removed while power is **OFF**.

Note: NEVER drops your HDD module or exposes it to high temperature, high humidity, or any hazardous environment. NEVER try to disassemble the module.

Static discharge may destroy your device and data. Always pick up the modules by touching the case only.

Touch Screen

Touch screen facilitates direct finger touch or pen input on the screen instead of mouse or touch pad.

PCMCIA Card

The computer supports 1x type-II PCMCIA card. To remove the card, push the eject button. The eject button can hide into the compartment by pushing it inward gently.

Express Card

The computer supports two form Express cards, 34 mm wide & 54 mm wide in an L-shape. You can install an Express Card while the computer is running. The computer automatically detects the card.

To install an Express Card:

- Hold the card with the top side of the card.
- Slide the card into the slot until the card is completely seated in its connector.

To remove an Express Card:

- Press the card and remove the card gently.

External Backlight Keyboard (Option)

The external backlight keyboard is equivalent to a full size desktop keyboard plus extra functions. The interface is via USB port.

Track point

The track point is functionally equivalent to a mouse. Pushing the track point may move the cursor on the screen. The 2 buttons act same as mouse buttons.

Backlight

Press **[I-O]** key for approximately 1 second turns keyboard backlight ON or OFF.



Docklight (Option)

Docklight acts as docking unit or port enhancer. It contains more ports that are not available on system unit.

Mount Docklight

1. Open the rubber cap on the docking connector.
2. Align the docking connector.
3. Attach Docklight.
4. Fix the screws.

Docklight ports

Top



1. Docking connector

Bottom and Left:

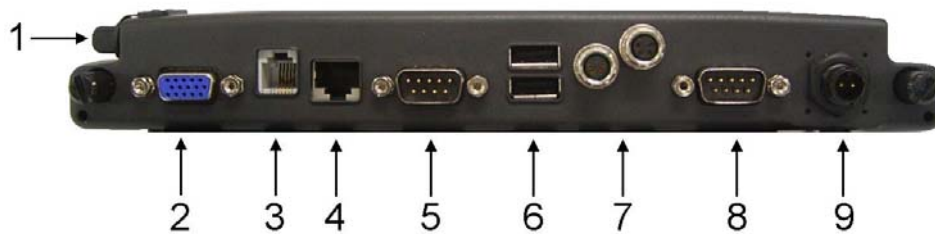

1. Audio jacks (Microphone/Speaker)
2. RGB port
3. Modem jack (RJ11)
4. LAN jack
5. Serial port (COM3)
6. USB port 1, 2 (standard type)
7. USB port 3, 4 (proprietary sealed type)
8. Serial port (COM2)
9. DC jack

Stand Unit (Option)

Stand unit can hold the system unit and Docklight with adjustable view angle. It can be used in office or in vehicle.

There are 2 configuration options:

- Stand unit only to accept system unit.
- Stand unit with Docklight hooked to accept system unit.

Mount Stand Unit

1. Open the rubber cap on the docking connector.
2. Align the computer into stand unit.
3. Push the lever to engage and fix.
4. Lock the computer.

Heater

Built-in heater and control circuit activates heating when computer is turned ON at temperature 0°C~-20°C (32°F~-4°F).

The heating is automatically; just turn ON power the heater controller will detect temperature and take over. The power indicator flashes while heating.

The computer would boot up when the internal temperature reaches safe level. It may take 5~20 minutes depends on how cold the temperature is. For temperature below -20°C (-4°F) the computer may never heat up.

Plug in AC or vehicle adapter for heating as battery power may become very low at low temperature.

RF Device

When RF device connect/function as one of (GPS/Bluetooth/HSDPA/Wi-Fi) started up, the RF led will be on, and then have to match up the "wireless manager" application software to control the device "on/off".

Please refer the illustration as below:



OPTIONAL DEVICES

Memory Card

The memory card will expand main memory to facilitate better system performance. The cards are available as following:

1GB, 2GB

2nd Battery

A Lithium Ion rechargeable 2nd battery may mount on the rear. It has 1.5 times capacity of primary battery and same Smart Battery compliance.

The computer's internal charger can detect 2nd battery and perform charging accordingly.

Wireless LAN Card

IEEE 802.11a,b,g wireless LAN card and rugged antenna.

MDC Modem Card

V.90 56K Fax/Modem

Vehicle Adapter

Converting power from car lighters (12~14V) or truck batteries (24~28V). It can power the system and charge the batteries simultaneously.

Caution: Remove or disconnect the vehicle adapter when leaving the vehicle to avoid battery exhaustion.

Dual Battery Charger

The charger provides two slots for the Primary and Secondary battery respectively. It allows charging of both batteries simultaneously and accepts power from AC adapter or Vehicle adapter. It takes approximately 3~4 hours to fully charge both batteries.

Docklight

Ports: Serial x 2, USB x 4, LAN, Modem, RGB, Microphone, and DC jack. The Docklight can attach to computer or stand unit for mobile or stationary operation.

Stand Unit

This acts as computer holder for office or vehicle operation and can work with or without Docklight.

RF Device

The RF device are available as following:

- GPS
- Bluetooth
- HSDPA
- Wi-Fi

SPECIFICATIONS

CPU

Intel Core2 Duo ULV U7500 1.06GHz - Processor

Memory

System memory	Standard: 512MB
Expandable	2GB
Cache memory	Internal level-II 2MB
Video memory	224MB (shared RAM)

Display

The display is an XGA 1024 x 786. The computer is also capable of displaying super XGA 1280 x 1024 dots on the LCD or external monitor.

Optionally, an SVGA compatible LCD (Liquid Crystal Display) of 800 x 600 dots (horizontal x vertical) is available.

LCD

Type:	8.4" Active TFT Colour
Resolution:	1024 x 768 pixels
Mode:	VGA, EGA, MGA, SVGA, XGA
Colour:	16.8 million true colours in 800 x 600 mode
Characters x Row:	80 x 25

Hard Disk Drive

Type:	2.5"
Interface:	SATA

Touch Screen

Type:	Resistive, polarised
Interface:	Serial (COM4)
Resolution:	>1024x1024

I/O Ports

- Serial port (DB9)
- LAN jack
- 1 type-II PCMCIA slots + 1 Express slot or 2 type II PCMCIA slots
- Docking port
- USB port
- DC jack

Dimensions and Weight

Width:	250mm (9.8")
Depth:	190mm (7.4")
Height:	42mm (1.65")
Weight:	1.9Kg (4.2 lb)

Note: *Weight varies depending on system configurations.*

AC Adapter

Input Voltage:	AC 100 - 240 V
Frequency:	50/60 Hz
Output Voltage:	DC 19V
Maximum Power:	90 Watts
Dimension:	133 mm (W) x 58mm (D) x 30mm (H)
Weight:	400 g (0.88 lb.)

Battery

Primary Battery:

Type:	6 x 18650 cells Lithium Ion
Capacity:	11.1V 4400mAH
Dimension:	150 mm (W) x 58 mm (D) x 20 mm (H)
Weight:	300 g (0.65 lb.)

2nd Battery (Option):

Type:	9 x 18650 cells Lithium Ion
Capacity:	11.1V 6600mAH
Dimension:	150 mm (W) x 90 mm (D) x 20 mm (H)
Weight:	500 g (1.1 lb.)

Keypad/Keyboard

Embedded Keypad:

Function keys:	F1~F6
----------------	-------

Optional External USB Keyboard:

Number of keys:	89
Key travel:	1.5 mm
Function:	Emulates standard 101/102-key keyboard
Trackpoint:	Equivalent to PS/2 mouse

Vehicle Adapter (Option)

Input Voltage	12V/24V (10~32V) Auto-sense
---------------	-----------------------------

Input Current	2.5A/5.5A max. (12V/24V respectively)
Output Voltage	19V +/-5%
Output Current	2.8A
Wiring	Cigarette lighter/Truck battery
Application	Car or Truck installation

Docklight DL-8I/DL-8M (Option)

Ports:	Serial x 2*, USB x 4*, LAN, Modem, RGB, Audio (microphone), DC jack
Dimensions:	250mm (9.8" W) x 34mm (1.3" D) x 38mm (1.5" H)
Weight:	0.45Kg (1 lb.) approximately

**: Serial ports: COM1 RS232 only, COM3 RS232 or optional RS422
USB ports: 2 standard connectors & 2 proprietary environmental sealed connectors*

Stand Unit (Option)

Dimensions:	240 mm (9.4" W) x 290mm (11.4" D) x 150mm (5.9" H)
Weight:	1.6Kg (3.5 lb.) approximately

Materials and Recycling

Materials of the computer are as follows:

Cabinet:	Magnesium alloy AZ91D UL grade PC+ABS GE C2800 or TN-3813BW
Bracket:	Aluminium 5052 Steel with Nickel plating Stainless Steel S304
PCB:	FR-4, UL 94V0
Battery:	Rechargeable Lithium Ion cells
Packing:	Carton: Unbleached paper Cushion: Recyclable PE Carrying bag: Recyclable PE Fibre User's Guide: Paper

If disposing of a unit, please recycle the parts according to local regulations. Alternatively, please contact the manufacturer regarding returning to them for disposal or recycling.

Environmental

Temperature:	Operating: DR886-I: 0 ~ 40°C (32 ~ 104°F) DR886-M: -20 ~ 50°C (-4 ~ 122°F)
Storage:	DR886-I: -20 ~ 60°C (-4 ~ 140°F) DR886-M: -40 ~ 70°C (-4 ~ 140°F)
Humidity:	Operating/Storage: 5~95% (non-condensing)
Altitude:	Operating/Storage: 4572 /12,180 meters (15,000/ 40,000 feet)

BIOS SETUP

Press **[F2]** at boot up to enter BIOS setup. Use arrow keys to select options and **[+/-]** to modify them. When finished, move to **"Exit"** and press **[Enter]** then confirm save by pressing **[Y]**.

Main Menu

Phoenix TrustedCore (tm) Setup Utility					
Main	Advanced	Security	TPM State	Boot	Exit
System Time: [16:19:20] System Date: [03/02/2007]			Item Specific Help		
Legacy Diskette A: [1.44/1.25MB 3½"]			<Tab>, <Shift-Tab>, or <Enter> selects field.		
▶ IDE Channel 0 Master	[None]				
▶ IDE Channel 0 Slave	[None]				
▶ IDE Channel 1 Master	[None]				
▶ IDE Channel 1 Slave	[None]				
System Memory: 640 KB Extended Memory: 1038336 KB					
F1 Help	↑↓ Select Item	-/+ Change Values	F9 Setup Defaults		
Esc Exit	↔ Menu	Enter Select ▶ Sub-Menu	F10 Save and Exit		

Note: The contents may vary depending on computer configurations.

Main Menu Selections

You can make the following selections on the Main Menu. Use the sub-menus for other selections.

Feature	Options	Description
System Time	HH:MM:SS	Set the system time Hour, Minute, Second.
System Date	MM/DD/YYYY	Set the system date Month, Day, and Year.
Legacy Diskette A	Disabled 360 Kb 5¼" 1.2 MB 5¼" 720 Kb 3½" 1.44/1.25 MB 3½" 2.88 MB 3½"	Select floppy type. Note that 1.25 MB 3½" references a 1024 byte/sector Japanese media format. The 1.25MB, 3½" diskette requires a 3-Mode floppy-disk drive.

IDE Channel 0 Master Sub-Menu

Phoenix TrustedCore ^(tm) Setup Utility		
Main		
IDE Channel 0 Master	[None]	Item Specific Help
Type:	[Auto]	User = you enter parameters of hard-disk drive installed at this connection. Auto = autotypes hard-disk drive installed here. CD-ROM = a CD-ROM drive is installed here. ATAPI Removable = removable disk drive is installed here.
Multi-Sector Transfers:	[Disabled]	
LBA Mode Control:	[Disabled]	
32 Bit I/O:	[Disabled]	
Transfer Mode:	[Standard]	
Ultra DMA Mode:	[Disabled]	
F1 Help	↑↓ Select Item	-/+ Change Values
Defaults		F9 Setup
Esc Exit	↔ Menu	Enter Select ▶ Sub-Menu
		F10 Save and Exit

IDE Channel 0 Master Sub-Menu Selections

You can make the following selections on the IDE Channel 0 Master sub-menu.

Feature	Options	Description
Type	Auto None ATAPI Removable CD-ROM IDE Removable Other ATAPI User	User = you enter parameters of hard-disk drive installed at this connection. Auto = autotypes hard disk drive installed here. CD-ROM = a CD-ROM drive is installed here. ATAPI Removable = removable disk drive is installed here.
32 Bit I/O	Disabled Enabled	This setting enables or disables 32 bit IDE data transfers.

IDE Channel 0 Slave Sub-Menu

Phoenix TrustedCore (tm) Setup Utility		
Main		
IDE Channel 0 Slave	[None]	Item Specific Help
Type:	[Auto]	User = you enter parameters of hard-disk drive installed at this connection. Auto = autotypes hard-disk drive installed here. CD-ROM = a CD-ROM drive is installed here. ATAPI Removable = removable disk drive is installed here.
Multi-Sector Transfers:	[Disabled]	
LBA Mode Control:	[Disabled]	
32 Bit I/O:	[Disabled]	
Transfer Mode:	[Standard]	
Ultra DMA Mode:	[Disabled]	
SMART Monitoring:	Disabled	
F1 Help	↑↓ Select Item	-/+ Change Values
Esc Exit	↔ Menu	Enter Select ▶ Sub-Menu
		F9 Setup Defaults
		F10 Save and Exit

IDE Channel 0 Slave Sub-Menu Selections

You can make the following selections on the IDE Channel 0 Slave sub-menu.

Feature	Options	Description
Type	Auto None ATAPI Removable CD-ROM IDE Removable Other ATAPI User	User = you enter parameters of hard-disk drive installed at this connection. Auto = autotypes hard disk drive installed here. CD-ROM = a CD-ROM drive is installed here. ATAPI Removable = removable disk drive is installed here.
32 Bit I/O	Disabled Enabled	This setting enables or disables 32 bit IDE data transfers.

IDE Channel 1 Master Sub-Menu

Phoenix TrustedCore (tm) Setup Utility			
Main			
IDE Channel 1 Master	[None]	Item Specific Help	
Type:	[Auto]	User = you enter parameters of hard-disk drive installed at this connection. Auto = autotypes hard-disk drive installed here. CD-ROM = a CD-ROM drive is installed here. ATAPI Removable = removable disk drive is installed here.	
Multi-Sector Transfers:	[Disabled]		
LBA Mode Control:	[Disabled]		
32 Bit I/O:	[Disabled]		
Transfer Mode:	[Standard]		
Ultra DMA Mode:	[Disabled]		
F1 Help	↑↓ Select Item	-/+ Change Values	F9 Setup
Defaults			
Esc Exit	↔ Menu	Enter Select ▶ Sub-Menu	F10 Save and Exit

IDE Channel 1 Master Sub-Menu Selections

You can make the following selections on the IDE Channel 1 Master sub-menu.

Feature	Options	Description
Type	Auto None ATAPI Removable CD-ROM IDE Removable Other ATAPI User	User = you enter parameters of hard-disk drive installed at this connection. Auto = autotypes hard disk drive installed here. CD-ROM = a CD-ROM drive is installed here. ATAPI Removable = removable disk drive is installed here.
32 Bit I/O	Disabled Enabled	This setting enables or disables 32 bit IDE data transfers.

IDE Channel 1 Slave Sub-Menu

Phoenix TrustedCore (tm) Setup Utility			
Main			
IDE Channel 1 Slave	[None]	Item Specific Help	
Type:	[Auto]	User = you enter parameters of hard-disk drive installed at this connection. Auto = autotypes hard-disk drive installed here. CD-ROM = a CD-ROM drive is installed here. ATAPI Removable = removable disk drive is installed here.	
Multi-Sector Transfers:	[Disabled]		
LBA Mode Control:	[Disabled]		
32 Bit I/O:	[Disabled]		
Transfer Mode:	[Standard]		
Ultra DMA Mode:	[Disabled]		
SMART Monitoring:	Disabled		
F1 Help	↑↓ Select Item	-/+ Change Values	F9 Setup Defaults
Esc Exit	↔ Menu	Enter Select ▶ Sub-Menu	F10 Save and Exit

IDE Channel 1 Slave Sub-Menu Selections

You can make the following selections on the IDE Channel 1 Slave sub-menu.

Feature	Options	Description
Type	Auto None ATAPI Removable CD-ROM IDE Removable Other ATAPI User	User = you enter parameters of hard-disk drive installed at this connection. Auto = autotypes hard disk drive installed here. CD-ROM = a CD-ROM drive is installed here. ATAPI Removable = removable disk drive is installed here.
32 Bit I/O	Disabled Enabled	This setting enables or disables 32 bit IDE data transfers.

General Help Window

Pressing <F1> or <Alt-H> on any menu brings up the General Help window that describes in detail the keys and functions for setup.

The scroll bar on the right of any window indicates that there is more than one page of information in the window. Use <PgUp> and <PgDn> to display all the pages. Pressing <Home> and <End> displays the first and last page. Pressing <Enter> displays each page and then exits the window. Press <Esc> to exit the current window.

Advanced Menu

Phoenix TrustedCore (tm) Setup Utility					
Main	Advanced	Security	TPM State	Boot	Exit
Legacy USB Support: [Enabled] Summary screen: [Disabled] QuickBoot Mode: [Enabled] Extended Memory Testing [None] IGD - Boot Type: [VBIOS Default] PS/2 Mouse [Auto Detect] PCI Express - Root Port 1: [Enabled] USB - Device 29, Function 7: [Enabled] Passive Cooling Trip Point [79 C] Processor Power Management [Enabled] ► SIO SMC227 CONFIGURATION				Item Specific Help Enable support for Legacy Universal Serial Bus	
F1 Help	↑↓ Select Item	-/+ Change Values	F9 Setup Defaults		
Esc Exit	↔ Menu	Enter Select ► Sub-Menu	F10 Save and Exit		

Warning: Incorrect settings may cause system malfunction. To correct it, restore the Setup Defaults with <F9>.

Advanced Menu Selections

You can make the following selections on the Advanced Menu.

Feature	Options	Description
Legacy USB Support	Disabled Enabled	Enable support for Legacy Universal Serial Bus
Summary screen	Disabled Enabled	Display system configuration on boot
QuickBoot Mode	Disabled Enabled	Allows the system to skip certain tests while booting. This will decrease the time needed to boot the system.
Extended Memory Testing	Normal Just zero it None	Determines which type of tests will be performed on extended memory (above 1M).
IGD - Boot Type	VBIOS Default CRT LFP CRT+LFP TV LFP-SDVO EFP	Select the Video Device that will be activated during POST

Feature	Options	Description
	TV-SDVO CRT+LFP-SDVO CRT+EFP	
PS/2 Mouse	Disabled Enabled Auto Detect	'Disabled' prevents any installed PS/2 mouse from functioning, but frees up IRQ 12. 'Enabled' forces the PS/2 mouse port to be enabled regardless if a mouse is present. 'Auto Detect' will enable the PS/2 mouse only if present. 'OS Controlled' only displayed if the OS controls the mouse.
PCI Express - Root Port 1	Disabled Enabled Auto	Control the PCI Express Port via this setup option. Disabled - Port always disabled. Enabled - Port always enabled. Auto - Only enable if card found. Note that if Root Port 1 is disabled, Root Ports 2-4 will be disabled as well.
USB - Device 29, Function 7	Disabled Enabled	Control USB 2.0 functionality through this Setup Item
Passive Cooling Trip Point	Disabled 15 C/23 C/31 C/39 C/ 47 C/55 C/63 C/71 C/ 79 C/87 C/95 C/103 C/ 111 C/119 C	This value controls the temperature of the ACPI Passive Trip Point – the point in which the OS will begin throttling the CPU. Note: When the DTS is enabled, only values below 97C are valid.
Processor Power Management	Enabled Disabled GV3 only C-States Only	Selects the Processor Power Management desired: Disabled = C-States and GV3 are disabled. GV3 Only = C-States and disabled. C-states Only = GV3 is disabled Enabled = C-States andGV3 are enabled.
SIO SMC227 CONFIGURATION		These items control the configuration of various National 393 SIO devices.

For most frequently altered setup “SIO SMC227 CONFIGURATION” please refers following:

Warning: Incorrect settings in **RS485/RS422** of COMx mode may cause SIO component Damage. Must be cautious before Setup.

SIO SMC227 Configuration Sub-Menu

Phoenix TrustedCore ^(tm) Setup Utility Advanced		Item Specific Help
SIO SMC227 CONFIGURATION		
COM1 port: [3F8-IRQ 4] COM1 mode: [RS232] COM2 port: [2F8-IRQ 3] COM2 mode: [RS232] COM3 port: [3E8-IRQ 10] COM3 mode: [RS232] COM4 port: [2E8-IRQ 5] COM4 mode: [RS232] Printer1: [Disabled] Printer2: [Disabled]	Configure COM1 using device options: [Disabled] No configuration [3F8-IRQ 4] Set the base I/O address for COM1	
F1 Help	↑↓ Select Item	-/+ Change Values
Esc Exit	↔ Menu	Enter Select ► Sub-Menu
F9	Setup Defaults	F10 Save and Exit

SIO SMC227 Configuration Sub-Menu Selections

You can make the following selections on the SIO SMC227 Configuration sub-menu.

Feature	Options	Description
COM1 port	Disabled 3F8-IRQ 4	Configure COM1 using device options: [Disabled] No configuration [3F8-IRQ 4] Set the base I/O address for COM1
COM1 mode	RS232 TTL1	Configure UART mode options: [RS232] : External Device [TTL1] : Internal Device
COM2 port	Disabled 2F8-IRQ 3	Configure COM2 using device options: [Disabled] No configuration [2F8-IRQ 3] Set the base I/O address for COM2
COM2 mode	RS232 TTL2	Configure UART mode options: [RS232] : External Device [TTL2] : Internal Device
COM3 port	Disabled 3E8-IRQ 10	Configure COM3 using device options: [Disabled] No configuration [3E8-IRQ 10] Set the base I/O address for COM3
COM3 mode	RS232 TTL3	Configure UART mode options: [RS232] : External Device [TTL3] : Internal Device

Feature	Options	Description
COM4 port	Disabled 2E8-IRQ 5	Configure COM4 using device options: [Disabled] No configuration [2E8-IRQ 5] Set the base I/O address for COM4
COM4 mode	RS232 TTL4	Configure UART mode options: [RS232] : External Device [TTL4] : Internal Device
Printer1	Disabled 378-IRQ 4	Configure Printer1 device options: [Disabled] No configuration [378-IRQ 7] Set the base I/O address for Printer1
Printer2	Disabled 3BC	Configure Printer2 device options: [Disabled] No configuration [3BC] Set the base I/O address for Printer2

Security Menu

Warning: If you forget user/supervisor password, the computer has to be returned to the manufacturer for EEPROM replacement.

Phoenix TrustedCore (tm) Setup Utility					
Main	Advanced	Security	TPM State	Boot	Exit
Processor Serial Number		[Disabled]			Item Specific Help
Set Supervisor Password		[Enter]			Controls detection of Processor Serial No. System must be reset or restarted from power-on for settings to take effect.
Set User Password		[Enter]			
Fixed disk boot sector:		[Normal]			
Diskette access:		[Supervisor]			
Password on boot:		[Disabled]			
USB Interface:		[Enabled]			
AC97 Audio Interface:		[Auto]			
AC97 Modem Interface:		[Auto]			
Cardbus/1394 Interface		[Auto]			
PCI Express – Root Port 3:		[Auto]			
PCI Express – Root Port 4:		[Auto]			
▶ RF Security Control:					
F1 Help	↑↓ Select Item	–/+ Change Values	F9 Setup Defaults		
Esc Exit	↔ Menu	Enter Select ▶ Sub-Menu	F10 Save and Exit		

Security Menu Selections

You can make the following selections on the Security Menu.

Feature	Options	Description
Processor Serial Number	Disabled Enabled	Controls detection of Processor Serial No. System must be reset or restarted from power-on for settings to take effect.
Set Supervisor password	Enter New Password Confirm New Password	Supervisor Password controls access to the setup utility.
Set User Password	Enter New Password Confirm New Password	User Password controls access to the system at boot.
Fixed disk boot sector	Normal Write Protect	Write protects boot sector on the hard disk to protect against viruses.
Diskette access	Supervisor	Control access to diskette drives
Password on boot	Disabled Enabled	Enables password entry on boot
USB Interface	Disabled Enabled	Control the listed USB Functions by setting the item to the desired value.
AC97 Audio Interface	Disabled Auto	Control Detection of the AC97 Audio Device. Auto = AC97 Audio will be enabled if present, disabled otherwise. Disabled = AC97 Audio will be unconditionally disabled, regardless of presence.

Feature	Options	Description
AC97 Modem Interface	Disabled Auto	Control Detection of the AC97 Modem Device. Auto = AC97 Modem will be enabled if present, disabled otherwise. Disabled = AC97 Modem will be unconditionally disabled, regardless of presence.
Cardbus/1394 Interface PCI Express – Root Port 3: PCI Express – Root Port 4:	Auto/Disabled Auto/Disabled/Enabled Auto/Disabled/Enabled	Control the PCI Express Port via this setup option. Disabled – Port always disabled. Auto – Only enable if card found. Note that if Root Port 1 is disabled, Root Ports 2-4 will be disabled as well.
RF Security Control		RF Security Control: Wireless LAN WWAN GPS Blue Tooth

For most frequently altered setup “RF Security Control” please refers following:

RF Security Control Sub-Menu

Phoenix TrustedCore ^(tm) Setup Utility Security		Item Specific Help
RF Security Control:		
Wireless Lan: [Disabled] WWAN: [Disabled] GPS: [Disabled] Blue Tooth: [Disabled]		Wireless Lan Control
F1 Help ↑↓ Select Item -/+ Change Values F9 Setup Defaults Esc Exit ↔ Menu Enter Select ► Sub-Menu F10 Save and Exit		

RF Security Control Sub-Menu Selections

You can make the following selections on the RF Security Control sub-menu.

Feature	Options	Description
Wireless Lan	Disabled Enabled	Wireless Lan Control Enabled Wireless function
WWAN	Disabled Enabled	WWAN Control Enabled WWAN function
GPS	Disabled Enabled	GPS Control Enabled GPS function
Blue Tooth	Disabled Enabled	Blue Tooth Control Enabled Blue Tooth function

TPM State Menu

Phoenix TrustedCore (tm) Setup Utility					
Main	Advanced	Security	TPM State	Boot	Exit
Current TPM State:			Enabled and Deactivated		Item Specific Help
Change TPM State:			[No Change]		Change TPM State
F1 Help	↑↓ Select Item	-/+ Change Values	F9 Setup Defaults		
Esc Exit	↔ Menu	Enter Select ▶ Sub-Menu	F10 Save and Exit		

TPM State Menu Selections

You can make the following selections on the TPM State Menu.

Feature	Options	Description
Change TPM State	No Change Enable & Activate Deactivate & Disable Clear	Change TPM State

Boot Menu

Phoenix TrustedCore (tm) Setup Utility							
Main	Advanced	Security	TPM State	Boot	Exit		
Boot priority order: 1: USB KEY: 2: USB FDC: 3: USB HDD: 4: IDE CD: 5: IDE HDD: 6: Legacy Network Card 7: PCI SCSI: 8: Excluded from boot order: : USB CDROM: : USB ZIP: : USB LS120: : PCI BEV: : Other USB: : PCI: : 1394 CDROM				Item Specific Help Keys used to view or configure devices: Up and Down arrows select a device. <+> and <-> moves the device up or down. <f> and <r> specifies the device fixed or removable. <x> excludes or includes the device to boot. <Shift + 1> enables or disables a device. <1 - 4> Loads default boot sequence.			
F1	Help	↑↓	Select Item	-/+	Change Values	F9	Setup Defaults
Esc	Exit	↔	Menu	Enter	Select ► Sub-Menu	F10	Save and Exit

The system will try to boot from device on top then the 2nd and so on. If there is more than one device in each category, only the device on top of sub-menu can boot up.

Exit Menu

Phoenix TrustedCore (tm) Setup Utility					
Main	Advance	Security	TPM State	Boot	Exit
Exit Saving Changes Exit Discarding Changes Load Setup Defaults Discard Changes Save Changes				Item Specific Help Exit System Setup and save your changes to CMOS.	
F1	Help	↑↓	Select Item	-/+	Change Values
Esc	Exit	↔	Menu	Enter	Select ► Sub-Menu
F9	Setup Defaults				
F10	Save and Exit				

Exit Menu Selections

You can make the following selections on the Exit Menu.

Feature	Options	Description
Exit Saving Changes		Exit System Setup and save your changes to CMOS.
Exit Discarding Changes		Exit utility without saving Setup data to CMOS.
Load Setup Defaults		Load default values for all SETUP items.
Discard Changes		Load previous values from CMOS for all SETUP items.
Save Changes		Save Setup Data to CMOS

UTILITIES AND DRIVERS

Note: Most device drivers are available in Windows. Only when the default driver does not work properly you need to install the factory bundled drivers.

The utility CD includes most drivers for the computer's installed devices. Consult dealer if any driver is missing.

Re-install drivers or perform "Driver Update" to replace the Windows default drivers.

Check **readme.txt** file on utility CD to get the newest information before starting to install drivers.

Chipset

Windows Driver Installation:

Insert the Driver CD into the CD-ROM. Click **infinst_autol.exe** in the directory of DR8EX\Driver\Chipset\2kXpVista3264 then follow the prompt to complete installation.

VGA Utility

Display Capability

Resolution & Colour	LCD	RGB	LCD + RGB
640x 480x 16-bit colour	O	O	O
640x 480x 24-bit colour	O	O	O
640x 480x 32-bit colour	O	O	O
800x 600x 64K colour	O	O	O
800x 600x 24-bit colour	O	O	O
800x 600x 32-bit colour	O	O	O
1024x 768x 16-bit colour	O	O	O
1024x 768x 24-bit colour	O	O	O
1280x 1024x 16-bit colour	X	O	X
1280x 1024x 24-bit colour	X	O	X
1280x 1024x 32-bit colour	X	O	X
1600x 1200x 16-bit colour	X	O	X
1600x 1200x 24-bit colour	X	O	X
1600x 1200x 32-bit colour	X	O	X
2048x 1536x 16-bit colour	X	O	X
2048x 1536x 24-bit colour	X	O	X
2048x 1536x 32-bit colour	X	O	X

The table lists typical display modes only. The system also supports standard video modes with lower resolution and colour.

Windows Driver Installation:

Insert the Driver CD into the CD-ROM. Click **win2k_xp1429.exe** in the directory of DR8EX\Driver\VGA\Intel_945GM\2kXp32 then follow prompt to complete driver installation. Windows may recommend using their driver, but you should confirm to change the factory bundled driver.

After restart and back to **Settings** window, choose proper **Colors** and **Screen Area**.

Audio Driver

Windows

Insert the Driver CD into the CD-ROM. Click **WDM_A400.exe** in the directory of DR8EX\Driver\Audio\2kXp_3264 then follow the prompt to complete installation.

USB 2.0

Windows does not need driver.

Touch Screen Driver

Enter BIOS Setup screen and set COM1 port as "TTL1". (COM1 has multiple connectivity, so it's necessary to setup. The optional COM4 may be configured as touch screen and doesn't need to configure the BIOS.) Afterwards, please cancel the prompt of installation wizard to setup the driver from the CD (\DR8EX\Driver\Touchscreen\DP9000\2kxpVista3264\PM...Universal...v1.0.0.8), and follow the prompt to complete installation and then restart.

PCMCIA Driver

Windows

The driver is automatically installed under Windows.

Mini PCI 1G AX92200 LAN

Insert the Driver CD into the CD-ROM. Click **Setup.exe** in the directory of E:\AX92200\DRIVER\RTL8110S\windows (612) then follow the prompt to complete installation.

Mini PCI INT8100 LAN

Windows does not need driver.

Mini PCI-E 1G RTL8111B LAN

Insert the Driver CD into the CD-ROM. Click **setup.exe** in the directory of DR8EX\Driver\PCIe_1G Lan\2kXp3264\RTL8168_8101E_664 then follow the prompt to complete installation.

Mini PCI-E Intel 3945ABG WLAN

*: **For the driver and software to function correctly on Windows, the recommendation is to install Service Pack 4 or later. Ensure that MSI support level 3.1 or above is installed. Use the Windows Installer 3.1 v2 or greater.**

Insert the Driver CD into the CD-ROM. Click **v11.1.0.5_xp32.exe** in the directory of DR8EX\Driver\PCIe_Intel WLAN\2kXp32 then follow the prompt to complete installation.

Fax/Modem Card Driver

Insert the Driver CD into the CD-ROM. Click **setup.exe** in the directory of DR8EX\Driver\MDC\mdc_w2kxp then follow the prompt to complete installation.

Wireless Manager

For flight safety and power saving reason, there is a utility provided easily to enable/disable RF devices of Wireless LAN/WWAN/GPS/Bluetooth in the run time. Insert the Driver CD into the CD-ROM. Click **setup.exe** in the directory of Utilities\Wireless Manager then follow the prompt to complete installation.

Input Management Services

Note:

1. *This utility is valid for only Windows.*
2. *“Function Key Manager” is better for tablet.*

Install

1. Run **setup.exe** from the directory of “Input Management Services” and then follows the prompt to complete.

Uninstall

1. Left-click the icon  and then launch “Exit”.
2. Run “Uninstall” from the path of “Start/All Programs/Input Management Services”.
3. Do not uninstall form Add/Remove Program on Control Panel.

Icon Function

Left-click the icon , there are 5 items:

1. Function Key Manager
2. On-Screen Keyboard
3. Launch Function key manager at startup
4. Launch On-Screen keyboard at logon
5. Exit

As the title is named, you could activate Function Key Manager and/or On-Screen Keyboard.

In addition, if you activate “Launch Function key manager at startup”,  will be on the task menu automatically after the system is launched. If you activate “Launch On-Screen keyboard at logon” and the log on password is set; On-Screen keyboard will pop-up automatically when system get into/recover from following modes, “**Logon/Logoff**”, “**Standby/Resume**”, “**Boot/Reboot**”, and “**Hibernate/Resume**”. However, On-Screen keyboard will disappear after password is input correctly and enter the Windows desktop and launch again.

Launch

Launch Function Key Manager, and this window will be shown:

Key	Function 1	Parameter 1	Function 2	Parameter 2
F1	None			
F2	None		None	
F3	None		None	
F4	None		None	
F5	None		None	
F6	None		None	
F7	None		None	
F8	None		None	

Load previous setting Save settings Build 060210

As “Function Key Manager” is titled, there are two function key sets (1 and 2). And eight function keys (Function 1 can be assigned from F1 to F8; Function 2 can be assigned from F2~F8) for each function key set could be defined by users. Each function key has 10 built-in functions. F1 is also used to switch between Function 1 & 2 set when “Toggle function 2” action is set; otherwise it’s same as other function keys.

1. None
2. Open/Execute a file
3. Open a URL in default browser
4. Replace with another key
5. Mouse cursor move to
6. Simulate mouse button click
7. Change display output
8. Rotate screen
9. Change desktop background colour
10. Chang desktop wallpaper
11. Launch On-Screen keyboard
12. Toggle function 2

Some functions need to assign additional parameters to work properly. Assign parameter for a function, click the mouse left button on the same row parameter field to enter the parameter or assign option in the pop-up dialog. Please refer to the following descriptions.

1. Open/Execute a file

Select a file from the pop-up window.

Set the proper file type if necessary, batch file (*.bat) is the default.

Open / Execute a file C:\readme.doc

2. Open a URL in default browser

Input the address of the website, e.g. www.opentec.com.au

3. Replace with another Key

The single key or combination key can be used. For example, press “Ctrl” and” “x” simultaneously, {Ctrl} x will be shown in the parameter blank. It means the combination key of Ctrl and x.



However, some combination keys are excluded. For example, “Ctrl+Alt+Del”, “Ctrl+Esc” and “Alt+Tab”; “Ctrl+Alt+Del” just jumps to run REAL “Ctrl+Alt+Del” right away, “Ctrl+Esc” goes to Start Menu, “Alt+Tab” will pop-up a window for selecting the working window.

4. Mouse cursor move to

Used to control the mouse cursor moving directions. “Up”, “Down”, “Left” and “Right” are the candidates.

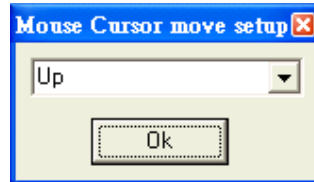

5. Simulate mouse button click

Used to define two button clicks of the mouse. “Left button click” and “Right button click” are alternatives.



6. Change display output

Switch display output among LCD, CRT and DVI. Just only one single mode can exist. “Enable External Monitor”, “Enable Notebook Display”, and “Enable External DVI” are the candidates. Please connect the external monitor or external DVI before launching this function.

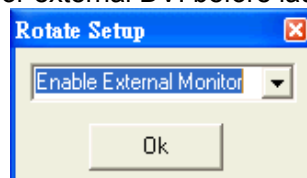

7. Rotate screen

The rotate setup provides four choices: Normal, 90, 180 and 270.

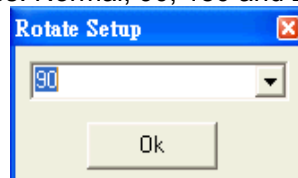

Please make sure Intel Extreme Graphics 2 driver/Control Panel application is installed and this icon  will be on the task menu. Activate the “Graphics Properties ...” from “Graphics Options”.

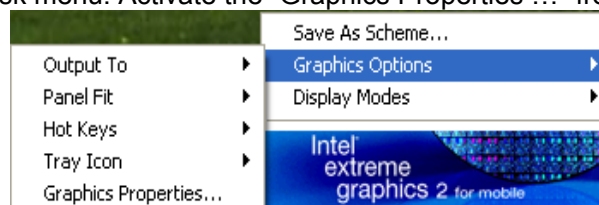

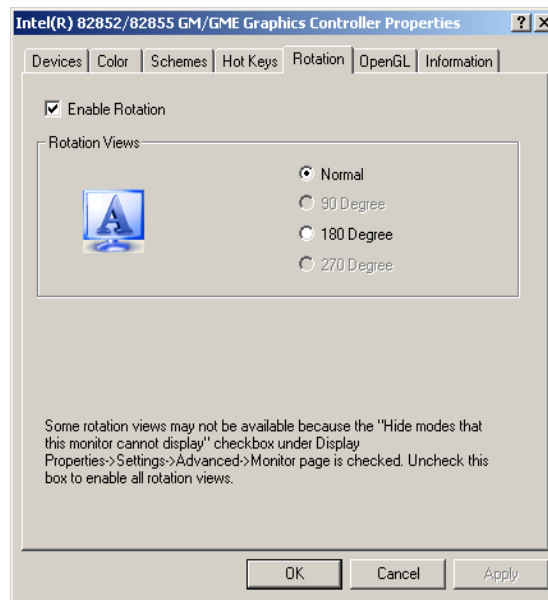

It results from “Hide modes that monitor cannot display” is enabled. So in such a situation, uncheck this box to enable all rotation views under Control Panel/Display/Display Properties/Setting/Advanced/Monitor.

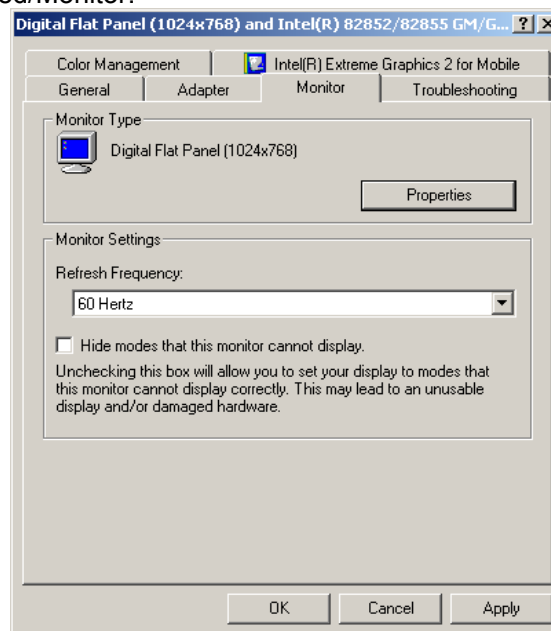

If you rotate screen to “Normal”, the “System Properties” windows will pop-up.

8. Change desktop background colour

Used to change background colour to make display more readable in the day or night. Select a colour from the pop-up colour palette.



9. Change desktop wallpaper

Used to change wallpaper to make display more readable in the day or night. Select a file from the pop-up window. Set the proper file type if necessary, bitmap Files (*.bmp) is the default.

10. Launch On-Screen keyboard

On-Screen keyboard is a utility that displays a virtual keyboard on the computer screen. Especially it is useful for tablet PC users; users could type data by using a pointing device or joystick. You can toggle this function key to enable/disable the on-screen keyboard.

11. Toggle function 2

This is only for “F1” in “Function 1” and no parameter has to be added. You can toggle this “F1” to launch the function key between “Function 1” and “Function 2”. The top banner of activated area will be changed into pink and the icon will show  for “Function 1” or  for “Function 2”.

When you have set this “Toggle function 2”, you could get additional 6 function keys in “Function 2”. In other words, 6 function keys in “Function 1” and 6 function keys in “Function 2” make 12 function keys in this Function Key Manager.

MAINTENANCE/SERVICE

Cleaning

ALWAYS turn OFF the power, unplug the power cord and remove the battery before cleaning.

The exterior of the system and display may be wiped with a clean, soft, and lint-free cloth. If there is difficulty removing dirt, apply non-ammonia, non-alcohol based glass cleaner to the cloth and wipe.

An air gun is recommended for cleaning water and dust. For salty water please clean with fresh water then blow-dry with an air gun.

Troubleshooting

Should the computer fail to function properly, the troubleshooting steps below may be followed.

- Check AC/vehicle adapter, battery, and the power source.
- Minimise the configuration, i.e. remove extra peripherals and devices.
- Remove the modules one by one (HDD, CD-ROM, Battery, etc.).
- Remove the software suspected.
- Set BIOS fail-safe default.
- Re-install operating system and application software.

RMA Service

If troubleshooting steps are unsuccessful, consult your dealer for an Return Material Authorisation (RMA). Goods will not be accepted by the manufacturer without an RMA and will be returned at the sender's expense.

Shipping instructions:

1. Remove any personal add-on devices or other media.
2. Use the original shipping container and packing materials, if possible.
3. If the original packing materials are not available, wrap the equipment with soft material (e.g. PU/PE form) then put the wrapped equipment into a hard cardboard shipping box.
4. Include a sheet with the following information: (Note: Please keep a copy of this sheet for your records.)
 - a. Name
 - b. Address
 - c. Unit serial number
 - d. Place and date of purchase or the original invoice number
 - e. Date of failure
 - f. A DETAILED description of the problems you have encountered including: The operating system, the add-on device installed (if any), the application software, the failure phenomenon, etc.
 - g. A list of the hardware/software configuration, if applicable.
5. Clearly mark the outside of the shipping box with the RMA #. If an RMA # is not present on the shipping box, receiving will be unable to identify it and it might be returned.
6. Unless prior arrangements have been made, the customer is responsible for all shipping costs. Unauthorised use of the company's shipping accounts is not permitted.



Opentec Solutions Pty Ltd

(a division of Inventis Technology)

Unit 9, 1-3 Endeavour Rd
Caringbah NSW 2229 Australia
Phone +61 2 9575 0925
Fax +61 2 9575 0999